

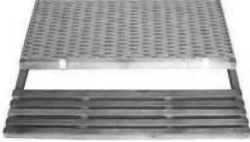











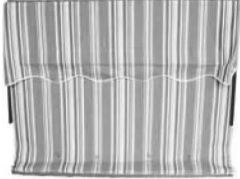



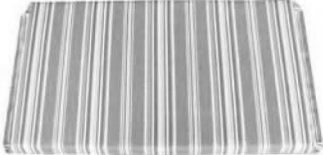









60-m



A		1pc	B		1pc
C		2pcs	D		2pcs
E		1pc	F		1pc
G		2pcs	H		2pcs
I		2pc	J		1pc
K		1pc	L		2pcs
M		2pcs	N		1pcs

tool		1pc	a	 33cm	6pcs
b	 41cm	3pcs	c		4pcs
d		1set	e		2pcs
f	 6×60mm	2pcs	g	 6×45mm	8pcs
h	 3.5×20mm	4pcs	i	 3.5×25mm	4pcs
j	 3.5×40mm	2pcs	k	 5×45mm	20pcs
l	 6×45mm	2pcs	m	 6×45mm	2pcs

# Schritt 1

NR.	Menge
a	2

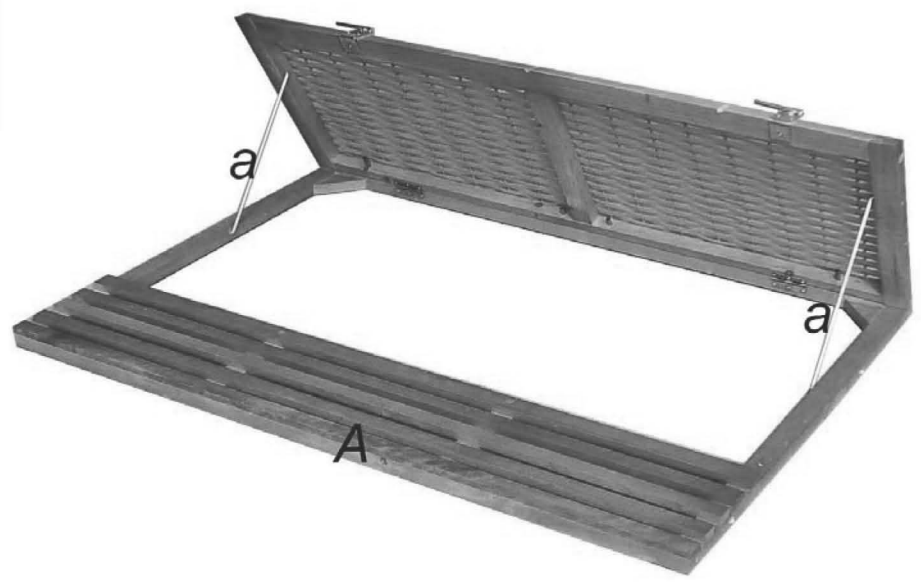

# Schritt 2

NR.	Menge
b	3
f	2

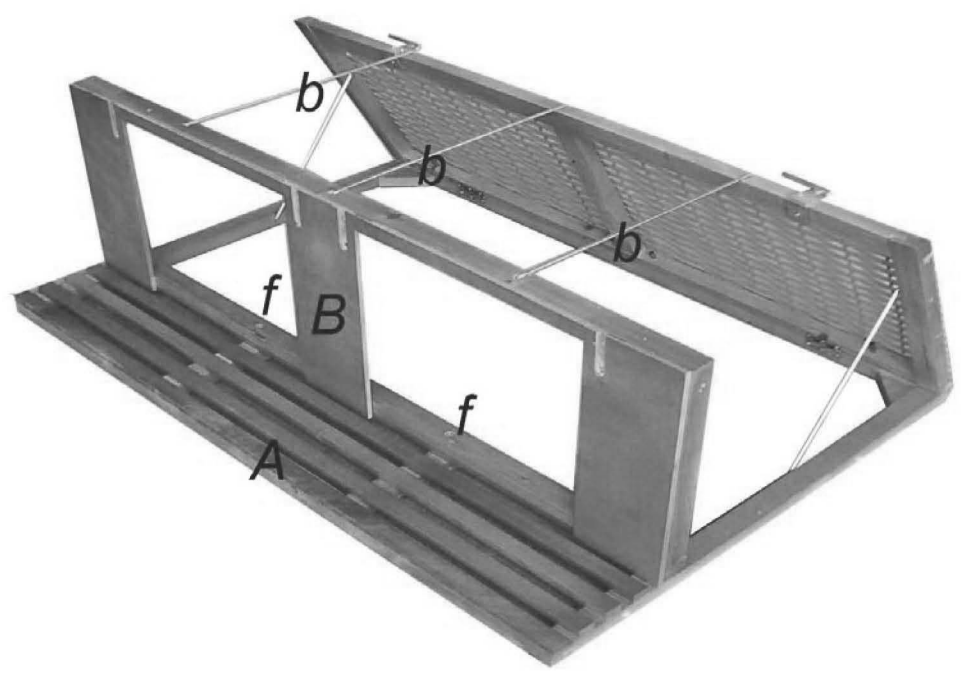

# Schritt 3

NR.	Menge
a	4
g	8

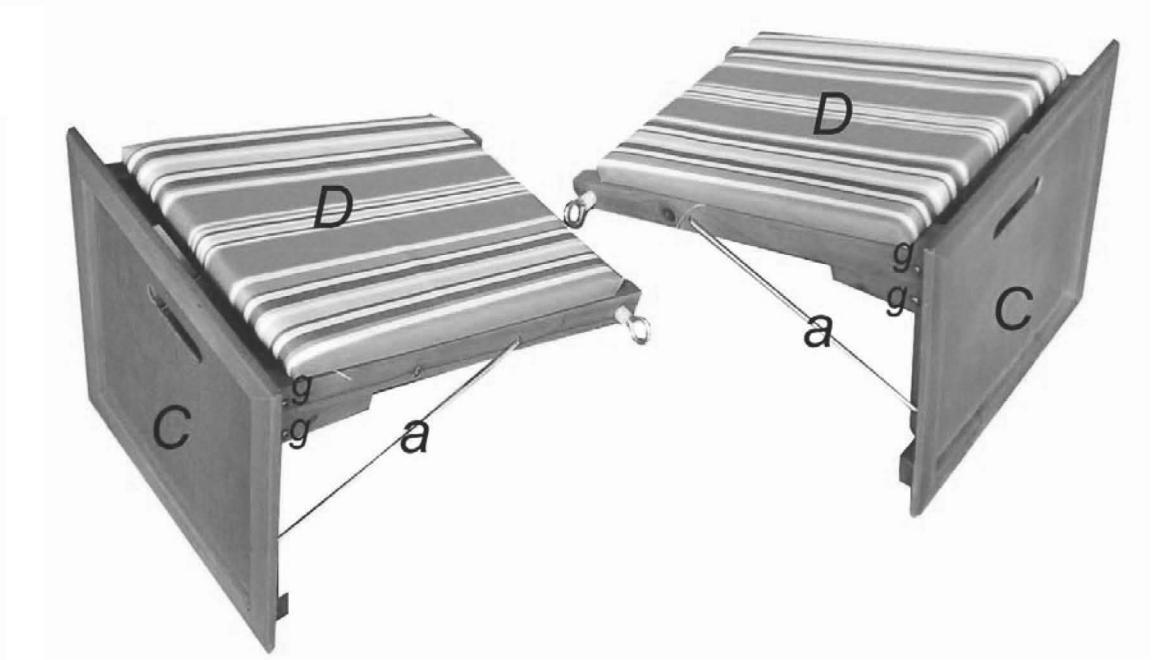

# Schritt 4

NR.	Menge
c	4
h	4

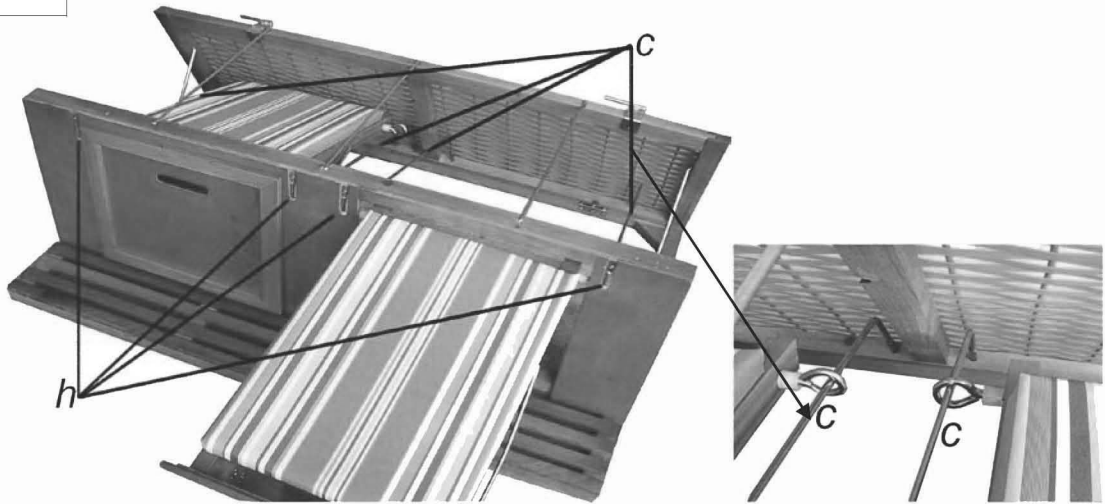

# Schritt 5

NR.	Menge
e	2
i	4
k	10

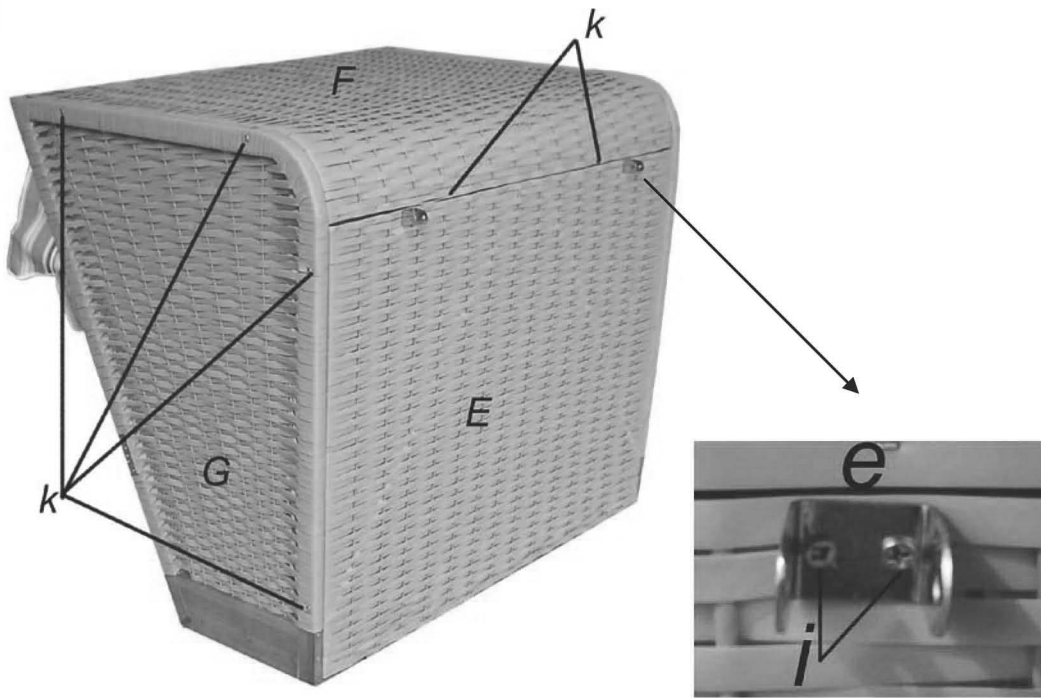

# Schritt 6

NR.	Menge
j	2
l	2



# Schritt 7

NR.	Menge
m	2

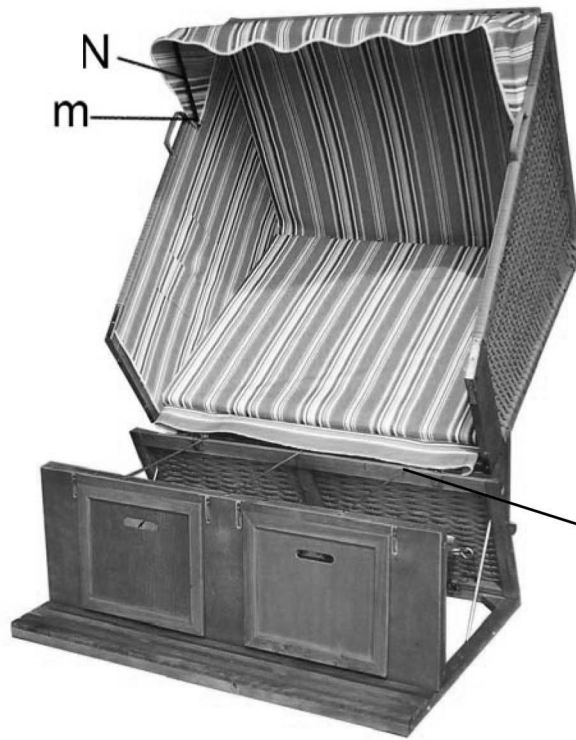

# Schritt 8

NR.	Menge
k	10
d	2

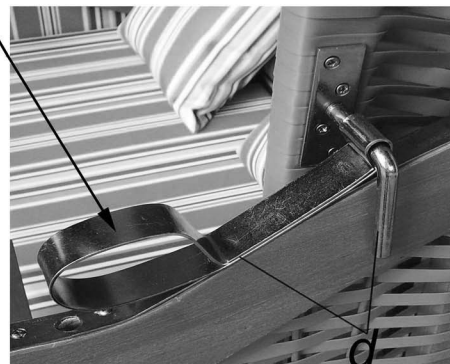
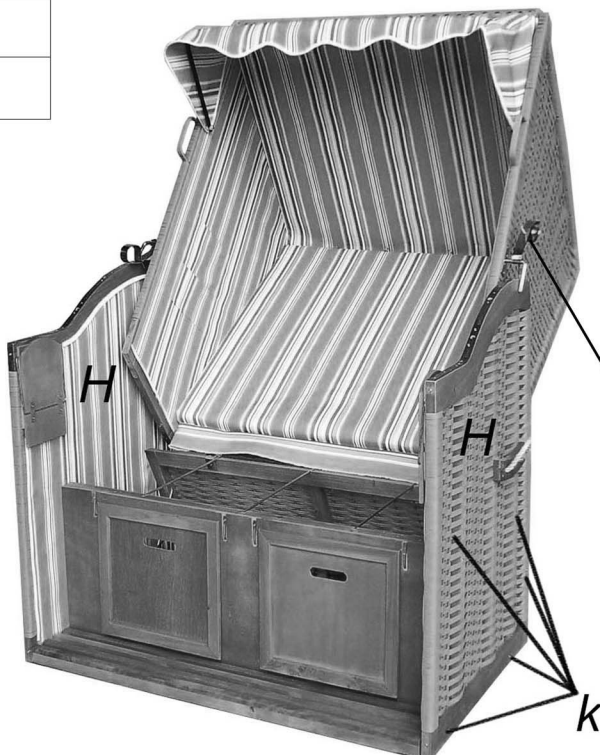

Schritt 9	
NR.	Menge



max load 250kgs